

SV-NET Miniature AC Servos

TBL-*i*

TBL-*V*



TBL mini Series

The TBL-i and TBL-V miniature servos are the newest additions to the TBL line. These AC servos start at 5 watts, with a frame size of 14.5mm. With torque densities higher than DC Brushless motors, the TBL minis can be run without gearing providing smooth, quiet motion with higher efficiencies and greater accuracies.

Both optical encoders and resolvers are available, providing flexibility and increasing mechanical reliability and robustness. Using resolvers as position encoders allows the TBL mini to be run in low temperature and high G environments, greatly expanding the range of applications in semiconductor, automotive, aerospace, medical, marine industries.

For even more torque in a small package, the TBL-V has zero backlash, high quality Harmonic Drive® gear box options, with 30:1, 50:1 and 100:1 ratios.

INDEX

| | |
|---|----|
| TBL-i • 14.5mm 3W, 5W, 10W, 15W servos, with Resolvers & Incremental Encoders | 3 |
| TBL-i • 19.5mm 10W, 16W, 20W, 30W servos, with Resolvers | 7 |
| TBL-i • 22mm 13W, 26W, 40W servos, with Incremental Encoders | 10 |
| TBL-V • 20mm & 28mm 5W, 10W, 20W, 30W servos, with Resolvers | 14 |
| TBL-V • 20mm & 28mm 5W - 30W servos, with HD® Reducers and Resolvers | 17 |
| TA8410 Driver Specifications | 20 |
| Motor and Driver Combination Matrix | 22 |

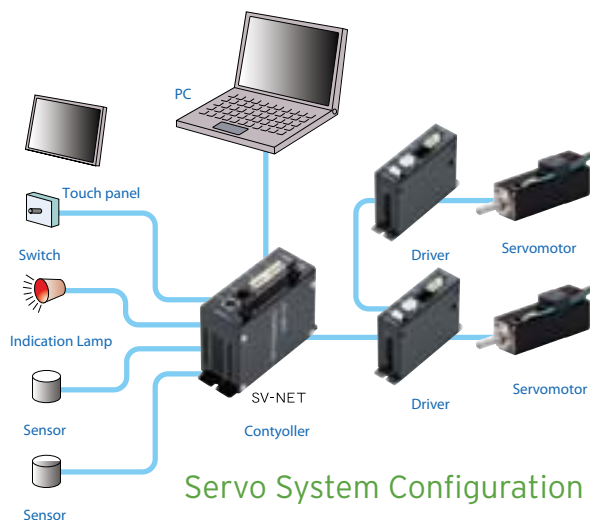

TBL-i mini AC Servos

PRODUCT LINE-UP // Super small size Servo Motors

Mounting flange size: 14.5mm



3W



5W



10W



15W

Mounting flange size: 19.5mm



10W



16W



20W



30W

Mounting flange size: 22mm



13W



26W



40W

Servo Driver

Servo Controller

TA8410 Series



TA8440 Series



14.5MM // 3 Watts - 15 Watts

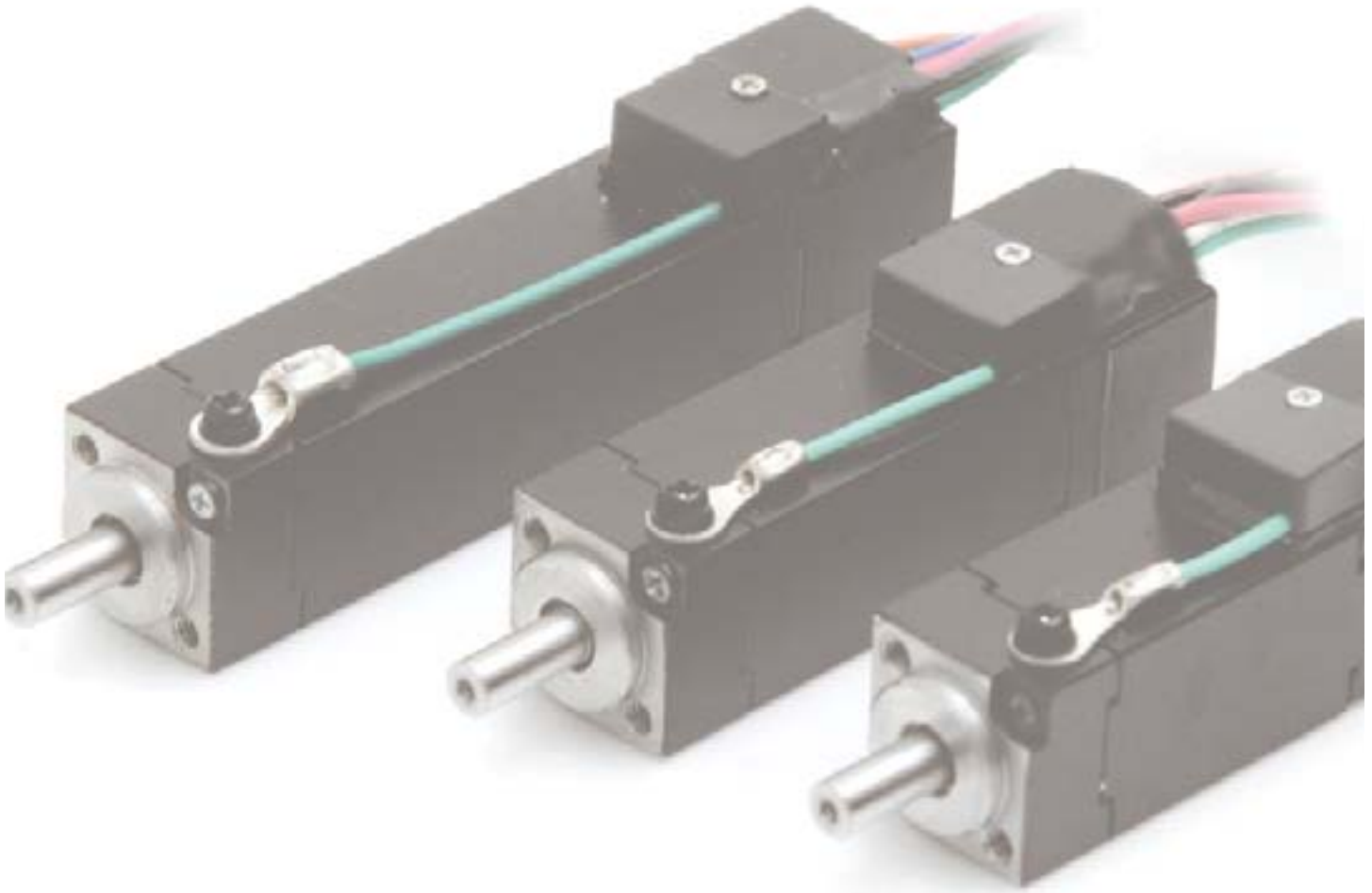

Features // TS486

- 14.5mm square frame size
- Position sensor options: resolver or optical incremental encoder
- Rated output: 3W, 5W, 10W, & 15W
- Rated speed 3,000r/min
- Maximum speed 6,000r/min

Model // TS486

TS486□N□□50E500

Output

TS4861 : 3W
TS4862 : 5W
TS4864 : 10W
TS4866 : 15W

Sensor type

4050 : Resolver
2250 : 2,048C/T (wire-saving type) Incremental Encoder
2850 : 4,096C/T (wire-saving type) Incremental Encoder

Specifications // Sensor : Resolver and Incremental Encoder

| Rated Output | (W) | 3 | 5 | 10 | 15 |
|-------------------------------------|--|---------------------------------------|---------------------------------------|--------------------------------------|---------------------------------------|
| Model | Resolver | TS4861N4050E500 | S4862N4050E500 | TS4864N4050E500 | TS4866N4050E500 |
| | 2,048C/T type | TS4861N2250E500 | TS4862N2250E500 | TS4864N2250E500 | TS4866N2250E500 |
| | 4,096C/T type | TS4861N2850E500 | TS4862N2850E500 | TS4864N2850E500 | TS4866N2850E500 |
| Input Voltage | (V) | DC24V | | | |
| Rated torque | N•m(kgf•cm) | 0.0095 (0.097) | 0.0159 (0.162) | 0.032 (0.3265) | 0.0477 (0.4867) |
| Stall torque | N•m(kgf•cm) | 0.0095 (0.097) | 0.0159 (0.162) | 0.032 (0.3265) | 0.0477 (0.4867) |
| Peak torque | N•m(kgf•cm) | 0.0285 (0.29) | 0.0477 (0.486) | 0.096 (0.98) | 0.1431 (1.46) |
| Rated speed | r/min | 3000 | 3000 | 3000 | 3000 |
| Maximum speed | r/min | 6000 | 6000 | 6000 | 6000 |
| | | 3000* | 3000* | 3000* | 3000* |
| Rotor moment of inertia | $[GD^2/4]kg\cdot m^2$ (gf•cm•s ²) | 0.00064X10 ⁻⁴ (0.00063) | 0.00096X10 ⁻⁴ (0.00098) | 0.0017X10 ⁻⁴ (0.00173) | 0.0026X10 ⁻⁴ (0.002653) |
| Rated power rate | kW/s | 1.46 | 2.6 | 6.1 | 8.75 |
| Mechanical time constant | ms | 2.63 | 1.83 | 1.32 | 1.17 |
| Static friction torque | N•m(kgf•cm) | 0.001 (0.01) | 0.001 (0.01) | 0.001 (0.01) | 0.0015 (0.015) |
| Insulation class | – | B | B | B | B |
| Insulation resistance | MΩ MIN | 10 | 10 | 10 | 10 |
| Insulation strength | – | AC 600V 60s | AC 600V 60s | AC 600V 60s | AC 600V 60s |
| Shaft end play | mm MAX | 0.5 | 0.5 | 0.5 | 0.5 |
| Maximum radial shaft load | N(kgf) | 8 (0.8) | 8 (0.8) | 8 (0.8) | 8 (0.8) |
| Maximum thrust shaft load | N(kgf) | 4 (0.4) | 4 (0.4) | 4 (0.4) | 4 (0.4) |
| Direction of rotation | – | U→V→W CCW | U→V→W CCW | U→V→W CCW | U→V→W CCW |
| Sensor misalignment | °e MAX | ±8 | ±8 | ±8 | ±8 |
| Rated armature current of E.D.C.M. | A (rms) | 0.68 | 1.0 | 1.573 | 2.14 |
| Stall armature current of E.D.C.M. | A (rms) | 0.62 | 0.94 | 1.526 | 2.07 |
| Noload armature current of E.D.C.M. | A (rms) | 0.06 | 0.06 | 0.047 | 0.07 |
| Peak armature current of E.D.C.M. | A (rms) | 1.92 | 2.875 | 4.62 | 6.28 |
| Torque constant of E.D.C.M. | N•m/A±10% (kgf•cm/A) | 0.0154 (0.1566) | 0.0169 (0.1728) | 0.02097 (0.214) | 0.023 (0.235) |
| Voltage constant of E.D.C.M. | V/(r/min) ±10% | 1.609X10 ⁻³ | 1.775x10 ⁻³ | 2.198X10 ⁻³ | 2.415X10 ⁻³ |
| Armature resistance of E.D.C.M. | Ω± 10% | 10.04 | 6.058 | 3.65 | 2.622 |
| Armature inductance of E.D.C.M. | mH±30% | 0.815 | 0.555 | 0.147 | 0.326 |
| Electrical time constant | ms | 0.081 | 0.092 | 0.11 | 0.12 |

* Incremental Encoder 4,096C/T type is limited to 3,000r/min due to the response frequency of the sensor.

Outline // TS486□N4050 (Resolver type)

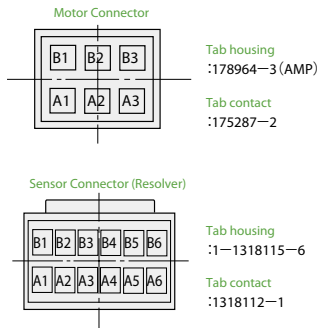
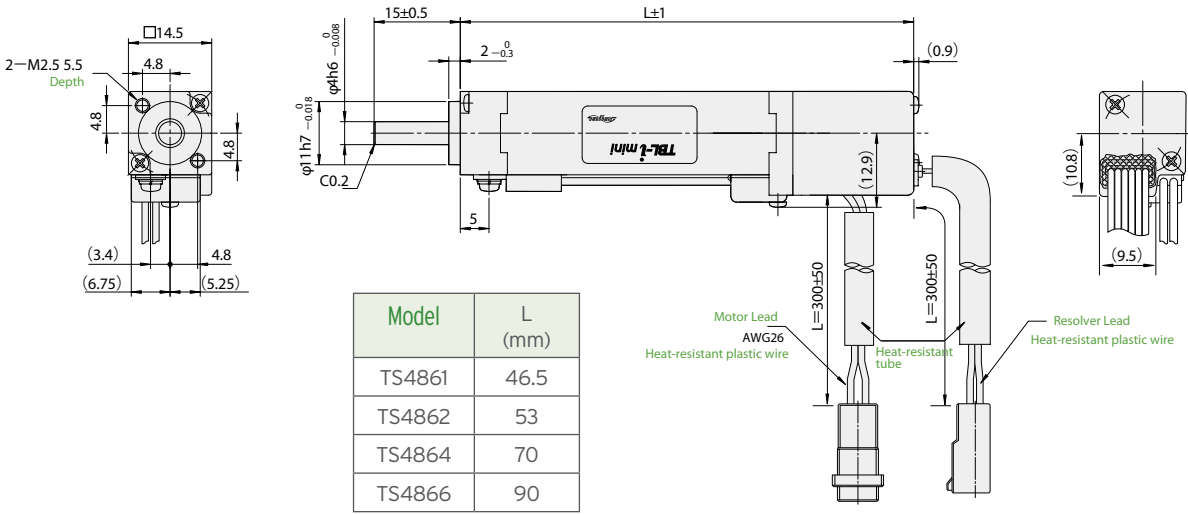

Motor Connection

| PIN No. | Function | Color |
|---------|----------|-------|
| A1 | U | Red |
| A2 | V | Wht |
| A3 | W | Blk |
| B1 | C.G | Grn |
| B2 | - | - |
| B3 | - | - |

Resolver Connection

| PIN No. | Function | Color |
|---------|----------|-------|
| A1 | S2 | Yel |
| A2 | S1 | Red |
| A3 | R1 | Wht |
| A4 | - | - |
| A5 | - | - |
| A6 | - | - |

| PIN No. | Function | Color |
|---------|----------|--------|
| B1 | S4 | Blu |
| B2 | S3 | Blk |
| B3 | R2 | Org |
| B4 | - | - |
| B5 | - | - |
| B6 | Shield | Shield |

Torque - Speed Characteristics

DC bus voltage (line to line) DC24V. (Output torque is dependent on the driving circuit.)

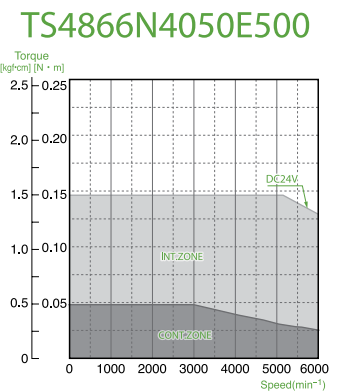
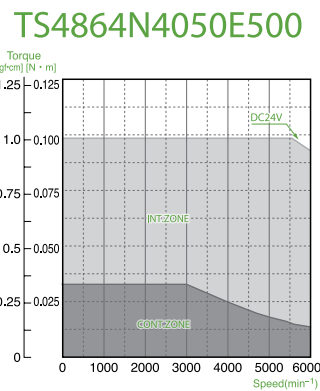
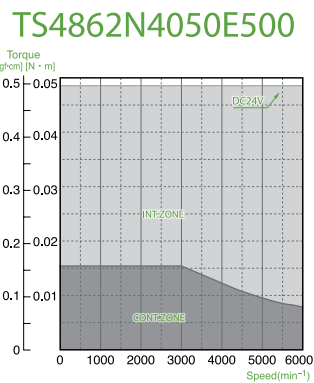
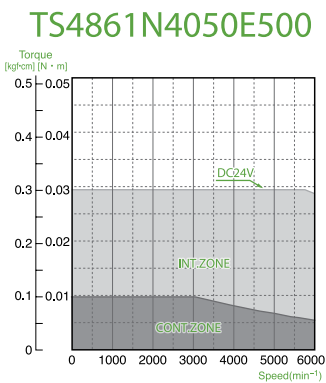

Outline // TS486□N2250 (2,048C/T), TS486□N2850 (4,096C/T)

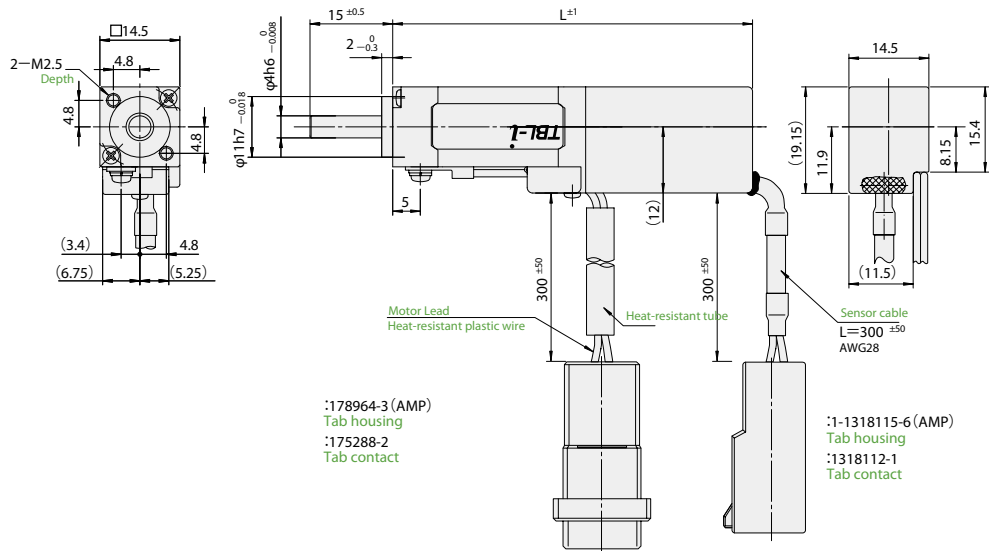

| Model | L (mm) |
|--------|--------|
| TS4861 | 65.5 |
| TS4862 | 72 |
| TS4864 | 89 |
| TS4866 | 109 |

:178964-3 (AMP)
Tab housing
:175288-2
Tab contact

:1-1318115-6 (AMP)
Tab housing
:1318112-1
Tab contact

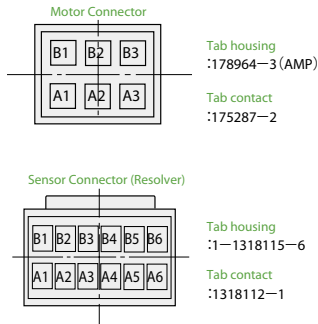

Motor Connection

| PIN No. | Function | Color |
|---------|----------|-------|
| A1 | U | Red |
| A2 | V | Wht |
| A3 | W | Blk |
| B1 | C.G | Grn |
| B2 | - | - |
| B3 | - | - |

Resolver Connection

| PIN No. | Function | Color |
|---------|----------|-------|
| A1 | UE, A | Yel |
| A2 | VE, B | Red |
| A3 | WE, Z | Wht |
| A4 | - | - |
| A5 | VCC | Red |
| A6 | - | - |

| PIN No. | Function | Color |
|---------|-------------------------------|---------|
| B1 | $\overline{UE}, \overline{A}$ | Blu/Blk |
| B2 | $\overline{VE}, \overline{B}$ | Grn/Blk |
| B3 | $\overline{WE}, \overline{Z}$ | Yel/Blk |
| B4 | - | - |
| B5 | GND | Blk |
| B6 | Shield | Shield |

Torque - Speed Characteristics

DC bus voltage (line to line) DC24V. (Output torque is dependent on the driving circuit.)

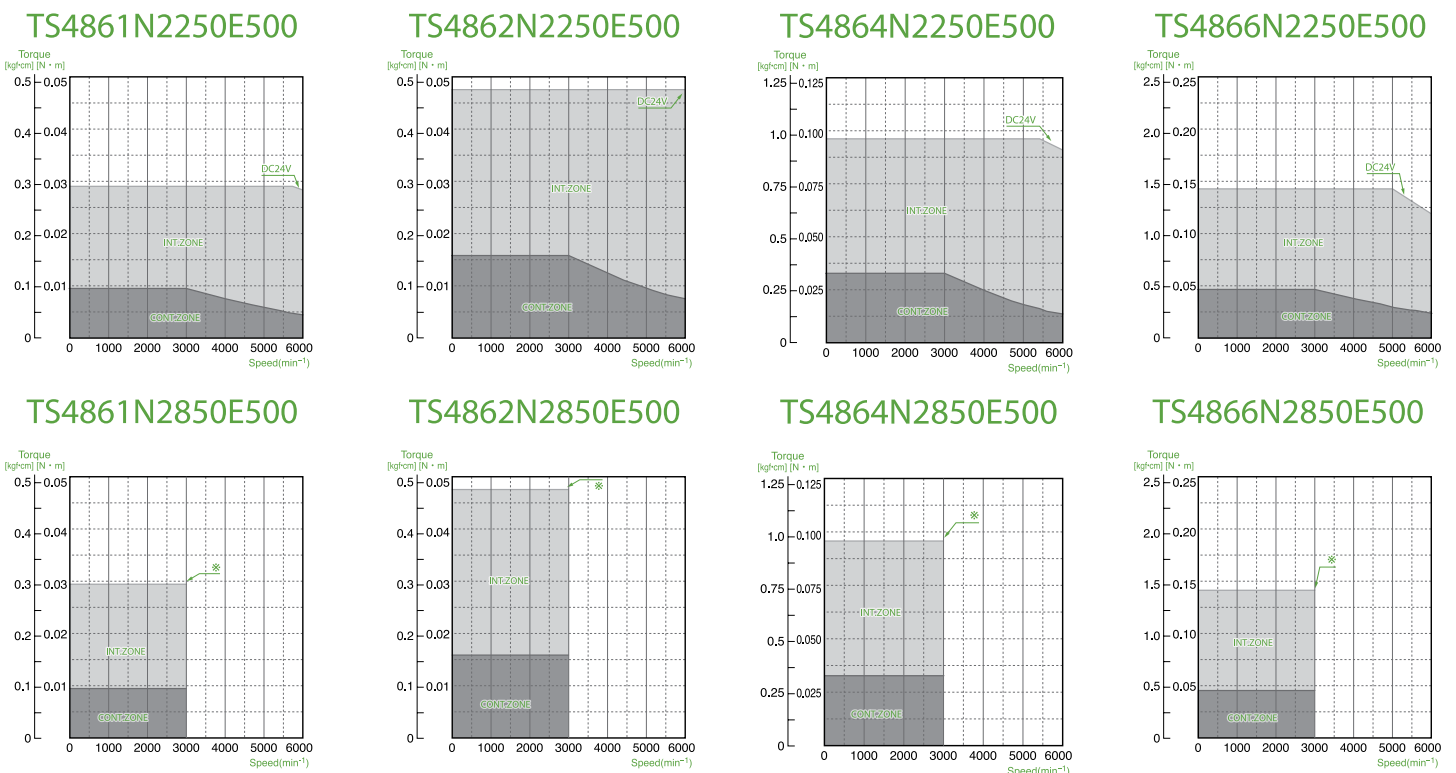

19.5MM // 10 watts - 30 watts

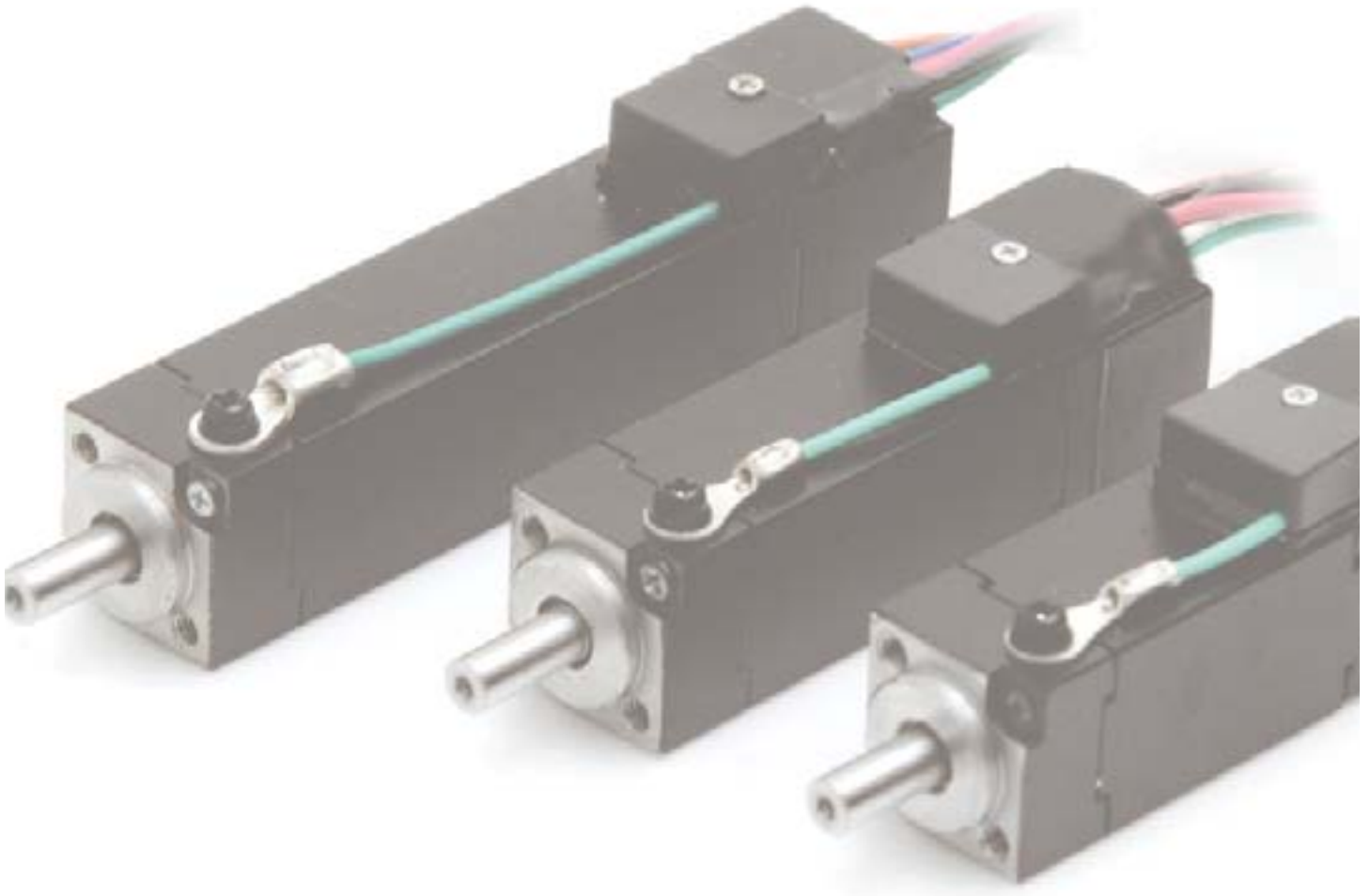

Features // TS487

- Super small motor size.
- Highly robust resolver for position feedback
- Rated output 10, 16, 20, 30W
- Rated speed 3,000r/min
- Maximum speed 6,000r/min

Model // TS487

TS487□N4050E500

Output

- TS4871 : 10W
- TS4872 : 16W
- TS4873 : 20W
- TS4875 : 30W

Specifications // Sensor : Resolver Type

| Rated Output | (W) | 3 | 5 | 10 | 15 |
|-------------------------------------|--|---------------------------------------|---------------------------------------|---------------------------------------|---------------------------------------|
| Model | - | TS4871N4050E500 | TS4872N4050E500 | TS4873N4050E500 | TS4875N4050E500 |
| Input Voltage | (V) | DC24V | | | |
| Rated torque | N•m(kgf•cm) | 0.032 (0.325) | 0.051 (0.52) | 0.064 (0.653) | 0.096 (0.98) |
| Stall torque | N•m(kgf•cm) | 0.032 (0.325) | 0.05 (0.52) | 0.064 (0.653) | 0.064 (0.653) |
| Peak torque | N•m(kgf•cm) | 0.096 (0.975) | 0.153 (1.558) | 0.192 (1.96) | 0.288 (2.94) |
| Rated speed | r/min | 3000 | 3000 | 3000 | 3000 |
| Maximum speed | r/min | 6000 | 6000 | 6000 | 6000 |
| Rotor moment of inertia | $[GD^2/4]kg\cdot m^2$ (gf•cm•s ²) | 0.0031X10 ⁻⁴ (0.003175) | 0.00496X10 ⁻⁴ (0.00506) | 0.00575X10 ⁻⁴ (0.00587) | 0.00945X10 ⁻⁴ (0.00964) |
| Rated power rate | kW/s | 3.26 | 5.24 | 7.1 | 9.76 |
| Mechanical time constant | ms | 2.86 | 2.1 | 2.0 | 1.99 |
| Static friction torque | N•m(kgf•cm) | 0.0015 (0.015) | 0.002 (0.02) | 0.002 (0.02) | 0.002 (0.02) |
| Insulation class | - | B | B | B | B |
| Insulation resistance | MΩ MIN | 100 | 10 | 10 | 100 |
| Insulation strength | - | AC 600V 60s | AC 600V 60s | AC 600V 60s | AC 600V 60s |
| Shaft end play | mm MAX | 0.04 | 0.5 | 0.5 | 0.04 |
| Maximum radial shaft load | N(kgf) | 24 (2.45) | 24 (2.45) | 24 (2.45) | 24 (2.45) |
| Maximum thrust shaft load | N(kgf) | 24 (2.45) | 24 (2.45) | 24 (2.45) | 24 (2.45) |
| Direction of rotation | - | U→V→W CCW | U→V→W CCW | U→V→W CCW | U→V→W CCW |
| Sensor misalignment | °e MAX | ±8 | ±8 | ±8 | ±8 |
| Rated armature current of E.D.C.M. | A (rms) | 0.18 | 2.29 | 2.87 | 3.9 |
| Stall armature current of E.D.C.M. | A (rms) | 1.72 | 2.2 | 2.78 | 3.82 |
| Noload armature current of E.D.C.M. | A (rms) | 0.08 | 0.09 | 0.09 | 0.08 |
| Peak armature current of E.D.C.M. | A (rms) | 5.25 | 6.71 | 8.42 | 11.54 |
| Torque constant of E.D.C.M. | N•m/A±10% (kgf•cm/A) | 0.01858 (0.1896) | 0.0231 (0.2358) | 0.023 (0.235) | 0.02513 (0.256) |
| Voltage constant of E.D.C.M. | V/(r/min) ±10% | 1.947X10 ⁻³ | 2.422x10 ⁻³ | 2.412X10 ⁻³ | 2.634X10 ⁻³ |
| Armature resistance of E.D.C.M. | Ω± 10% | 3.326 | 2.338 | 1.889 | 1.389 |
| Armature inductance of E.D.C.M. | mH±30% | 0.735 | 0.6 | 0.51 | 0.332 |
| Electrical time constant | ms | 0.22 | 0.26 | 0.27 | 0.24 |

Outline // TS487□N40500E500 (Resolver type)

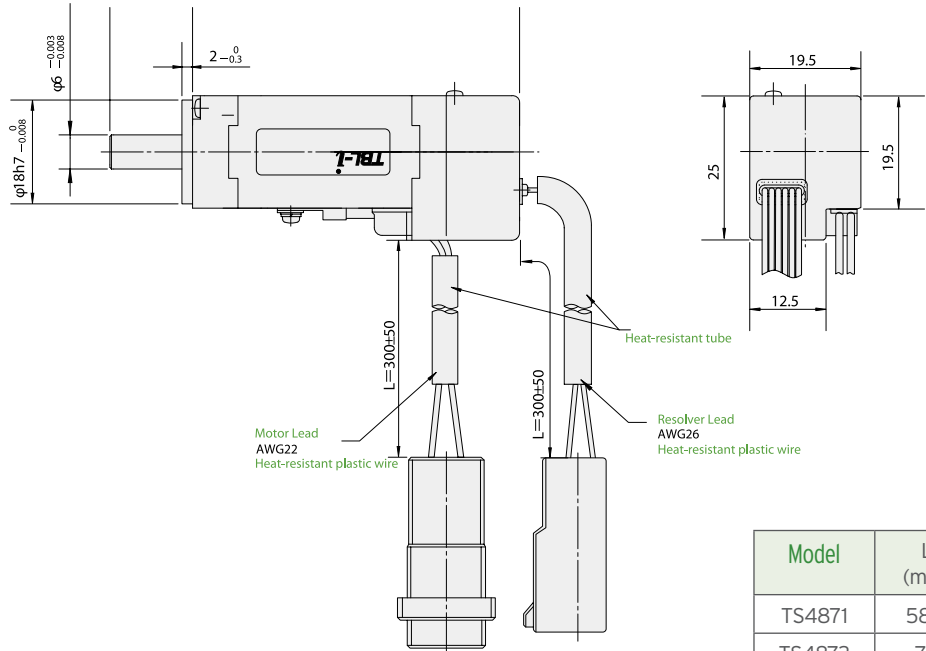
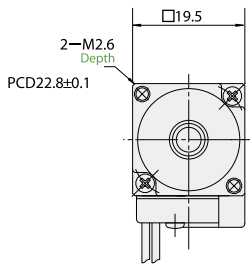

:178964-3
Tab housing
:175288-2
Tab contact

:1-1318115-6
Tab housing
:1318112-1
Tab contact

| Model | L (mm) |
|--------|--------|
| TS4871 | 58.5 |
| TS4872 | 70 |
| TS4873 | 75 |
| TS4875 | 101 |

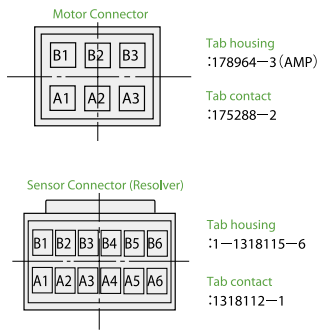

Motor Connection

| PIN No. | Function | Color |
|---------|----------|-------|
| A1 | U | Red |
| A2 | V | Wht |
| A3 | W | Blk |
| B1 | C.G | Grn |
| B2 | - | - |
| B3 | - | - |

Sensor (Resolver) Connection

| PIN No. | Function | Color |
|---------|----------|-------|
| A1 | S2 | Yel |
| A2 | S1 | Red |
| A3 | R1 | Wht |
| A4 | - | - |
| A5 | - | - |
| A6 | - | - |

| PIN No. | Function | Color |
|---------|----------|-------|
| B1 | S4 | Blu |
| B2 | S3 | Blk |
| B3 | R2 | Org |
| B4 | - | - |
| B5 | - | - |
| B6 | - | - |

Torque - Speed Characteristics

DC bus voltage (line to line) DC24V. (Output torque is dependent on the driving circuit.)

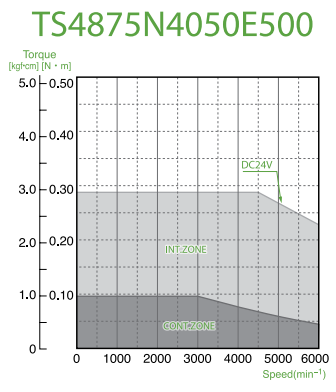
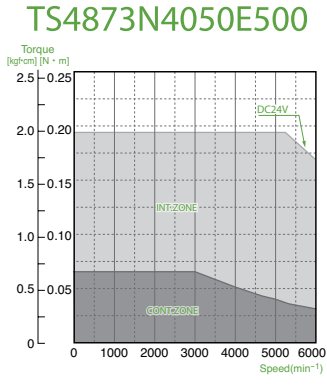
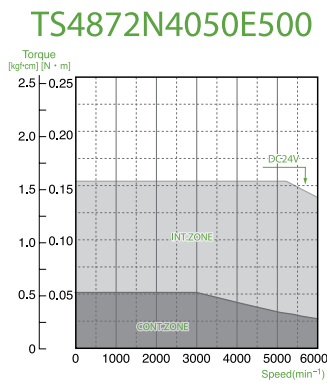
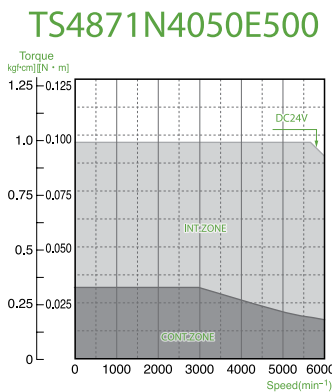

22MM // 13 Watts - 40 Watts

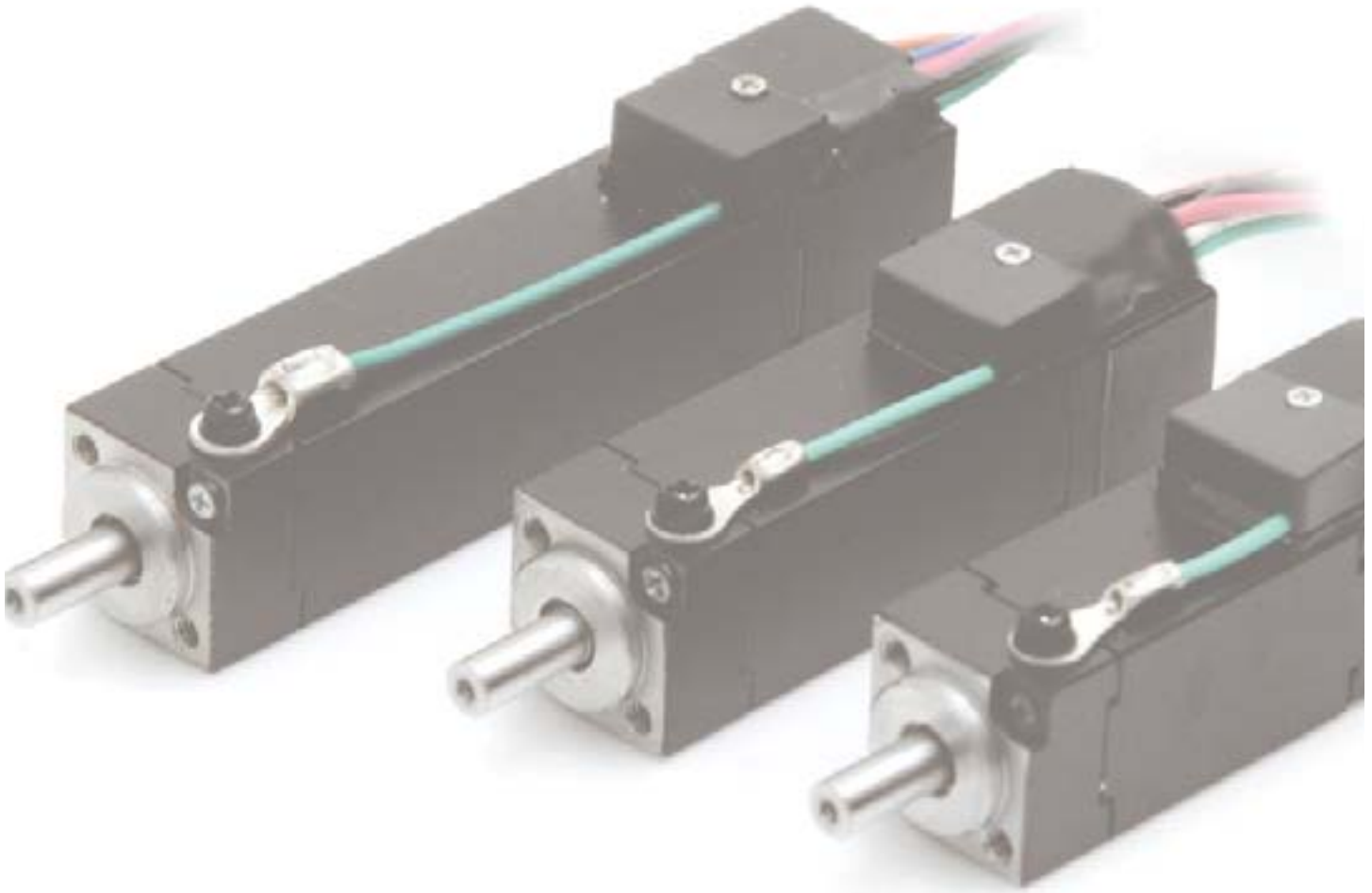

Features // TS463

- Super small motor size.
- Servo Motor sensor line-up are 2,000C/T and 2,048C/T incremental encoder type.
- Rated output 13, 26, & 40W
- Rated speed 4,000r/min
- Maximum speed 5000r/min

Model // TS463

TS463□N2□50E510

Output

TS4871 : 13W
TS4872 : 26W
TS4873 : 40W

Sensor type

2050 : 2,000C/T (wire-saving type) Incremental Encoder
2250 : 2,048C/T (wire-saving type) Incremental Encoder

Specifications // Sensor : Incremental Encoder Type

| | | | | |
|--------------------------------------|--|-----------------------------------|-----------------------------------|-----------------------------------|
| Rated Output | (W) | 13 | 26 | 40 |
| Model | 2,000C/T type | TS4631N2050E510 | TS4632N2050E510 | TS4873N4050E500 |
| | 2,048C/T type | TS4631N2250E510 | TS4632N2250E510 | TS4633N2250E510 |
| Input voltage | (V) | DC24V | | |
| Rated torque | N•m(kgf•cm) | 0.031 (0.32) | 0.062 (0.63) | 0.095 (0.97) |
| Stall torque | N•m(kgf•cm) | 0.031 (0.32) | 0.062 (0.63) | 0.095 (0.97) |
| Peak torque | N•m(kgf•cm) | 0.094 (0.96) | 0.185 (1.89) | 0.285 (2.91) |
| Rated speed | r/min | 4000 | 4000 | 4000 |
| Maximum speed | r/min | 5000 | 5000 | 5000 |
| Rotor moment of inertia | $[GD^2/4]kg\cdot m^2$ (gf•cm•s ²) | 0.003X10 ⁻⁴ (0.003) | 0.004X10 ⁻⁴ (0.004) | 0.006X10 ⁻⁴ (0.006) |
| Rated power rate | kW/s | 3.4 | 9.7 | 15.4 |
| Mechanical time constant | ms | 2.2 | 1.2 | 1.2 |
| Static friction torque | N•m(kgf•cm) | 0.001 (0.01) | 0.001 (0.01) | 0.001 (0.01) |
| Insulation class | - | B | B | B |
| Insulation resistance | MΩ MIN | 100 | 10 | 10 |
| Insulation strength | - | AC 600V 60s | AC 600V 60s | AC 600V 60s |
| Shaft end play | mm MAX | 0.04 | 0.5 | 0.5 |
| Maximum radial shaft load | N(kgf) | 24 (2.45) | 24 (2.45) | 24 (2.45) |
| Maximum thrust shaft load | N(kgf) | 24 (2.45) | 24 (2.45) | 24 (2.45) |
| Direction of rotation | - | U→V→W CCW | U→V→W CCW | U→V→W CCW |
| Sensor misalignment | °e MAX | ±8 | ±8 | ±8 |
| Rated armature current of E.D.C.M. | A (rms) | 1.44 | 2.92 | 4.0 |
| Stall armature current of E.D.C.M. | A (rms) | 1.1 | 2.52 | 3.6 |
| No-load armature current of E.D.C.M. | A (rms) | 0.34 | 0.4 | 0.4 |
| Peak armature current of E.D.C.M. | A (rms) | 3.66 | 8.0 | 11.2 |
| Torque constant of E.D.C.M. | N•m/A±10% (kgf•cm/A) | 0.029 (0.29) | 0.025 (0.25) | 0.026 (0.27) |
| Voltage constant of E.D.C.M. | V/(r/min) ±10% | 30X10 ⁻³ | 2.6x10 ⁻³ | 2.73X10 ⁻³ |
| Armature resistance of E.D.C.M. | Ω± 10% | 6.2 | 2.0 | 1.36 |
| Armature inductance of E.D.C.M. | mH±30% | 1.4 | 0.51 | 0.30 |
| Electrical time constant | ms | 0.22 | 0.26 | 0.22 |

Outline // TS463□N2□50E510 (Sensor : Incremental Encoder Type)

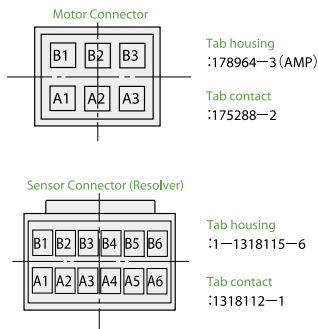
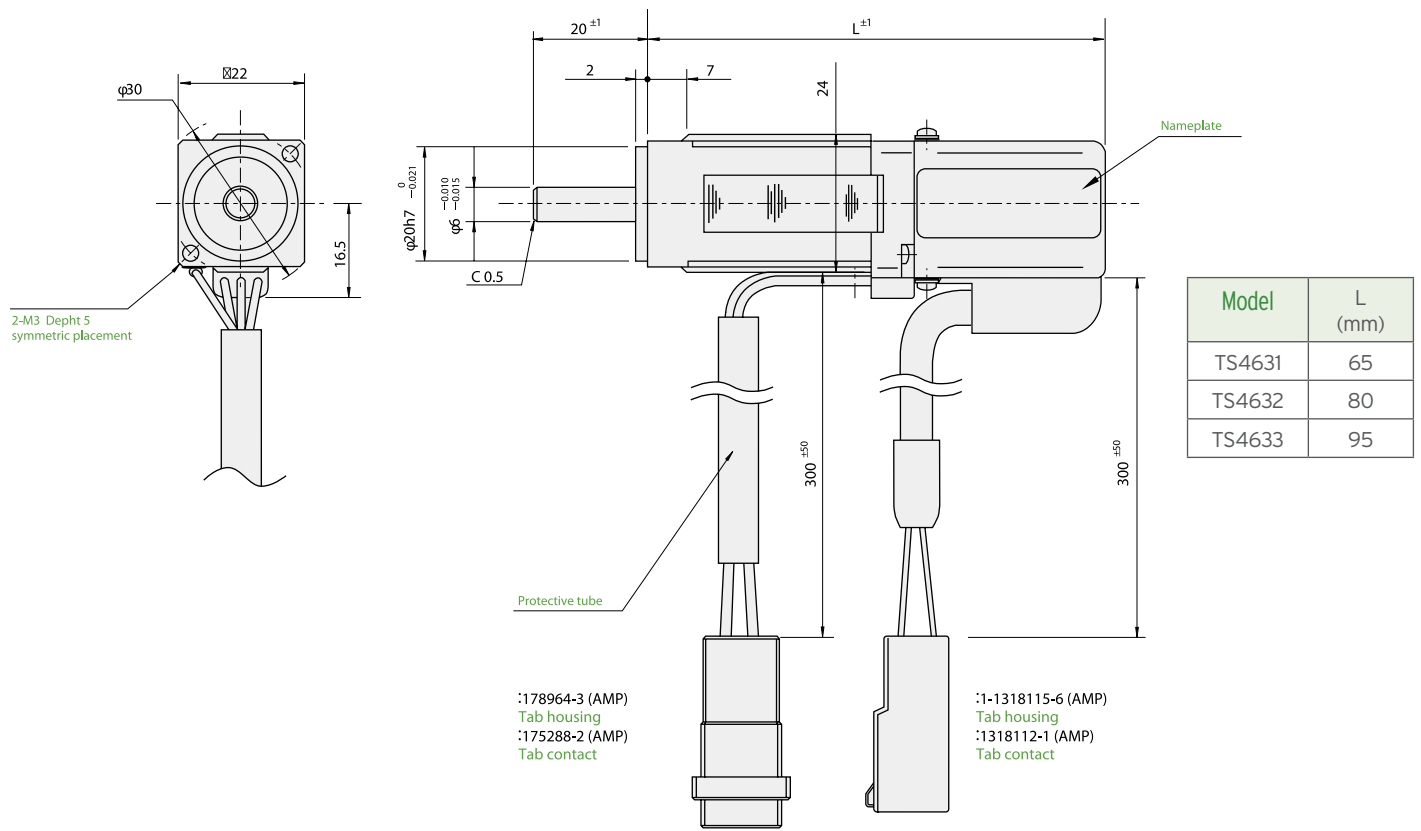

Motor Connection

| PIN No. | Function | Color |
|---------|----------|---------|
| A1 | U | Red |
| A2 | V | Wht |
| A3 | W | Blk |
| B1 | C.G | Grn/Yel |
| B2 | - | - |
| B3 | - | - |

Encoder Connection

| PIN No. | Function | Color |
|---------|----------|-------|
| A1 | UE, A | Blu |
| A2 | VE, B | Grn |
| A3 | WE, Z | Yel |
| A4 | - | - |
| A5 | VCC | Red |
| A6 | - | - |

| PIN No. | Function | Color |
|---------|-------------------------------|---------|
| B1 | $\overline{UE}, \overline{A}$ | Blu/Blk |
| B2 | $\overline{VE}, \overline{B}$ | Grn/Blk |
| B3 | $\overline{WE}, \overline{Z}$ | Yel/Blk |
| B4 | - | - |
| B5 | GND | Blk |
| B6 | Shield | Shield |

Torque - Speed Characteristics

DC bus voltage (line to line) DC24V. (Output torque is dependent on the driving circuit.)

TS4631N2050E510
TS4631N2250E510

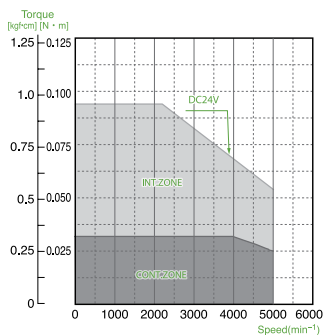

TS4632N2050E510
TS4632N2250E510

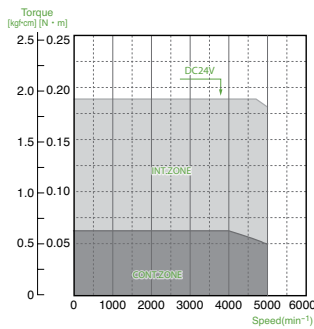

TS4633N2050E510
TS4633N2250E510

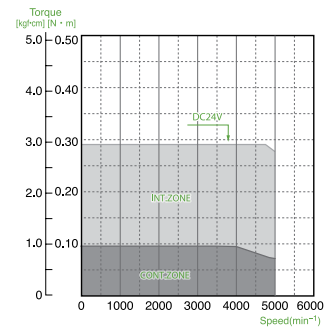

TBL-V Series AC Servo motor

PRODUCT LINE-UP // Super small size Servo motors

AC Servo Motor Sizes: 20mm & 28mm

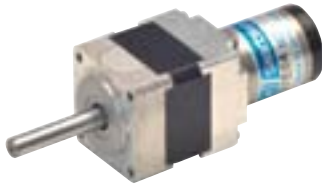

20 mm



28 mm

AC Servo Motor with Reduction Gearing Sizes: 20.4mm & 30mm



20.4 mm



30 mm

Servo Driver



TBL-V Series AC Servo motor

20-28 MM // 5 Watts to 30 Watts

Features // TS47

- Small servo motors mechanically compatible with standard small stepper motor flange and shaft sizing.
- Highly reliable resolver: Equipped with the world's smallest resolver (Smartsyn).
- Able to withstand greater temperature, vibration & shock ranges.



Model // TS47

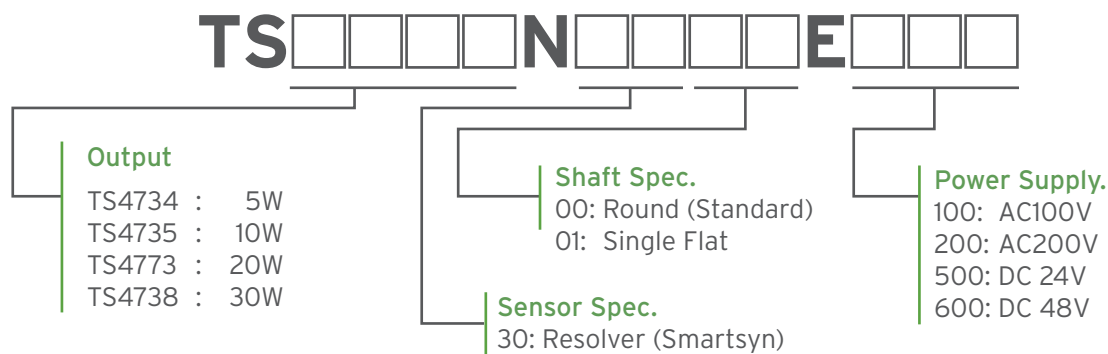

Specifications // TS47

| Mounting Flange | | Model | Driver Voltage | Output | Rated Torque | Max Torque | Rated Current | Max Current | Rated Speed | Max Speed | Rotor Inertia | Mass |
|-----------------|------|--------|----------------|--------|--------------|------------|---------------|-------------|-------------|-----------|-------------------------|------|
| Stepper | (mm) | | (V) | (W) | (N·m) | (N·m) | (Arms) | (Arms) | (r/min) | (r/min) | (kg·m ²) | (kg) |
| #8 | 20 | TS4734 | DC24, 48 | 5 | 0.010 | 0.029 | 1.4 | 3.2 | 5,000 | 8,000 | 0.0009x10 ⁻⁴ | 0.09 |
| | | | AC100, 200 | | | | 0.7 | 1.7 | | | | |
| | | TS4735 | DC24, 48 | 10 | 0.019 | 0.057 | 1.1 | 3.0 | 5,000 | 8,000 | 0.0014x10 ⁻⁴ | 0.10 |
| | | | AC100, 200 | | | | 0.6 | 1.6 | | | | |
| #11 | 28 | TS4737 | DC24, 48 | 20 | 0.038 | 0.115 | 2.7 | 6.9 | 5,000 | 8,000 | 0.0064x10 ⁻⁴ | 0.18 |
| | | | AC100, 200 | | | | 0.9 | 2.4 | | | | |
| | | TS4738 | DC24, 48 | 30 | 0.057 | 0.172 | 2.6 | 7.1 | 5,000 | 8,000 | 0.0083x10 ⁻⁴ | 0.19 |
| | | | AC100, 200 | | | | 0.9 | 2.4 | | | | |

Outline // □20-mm Square (5W, 10W)

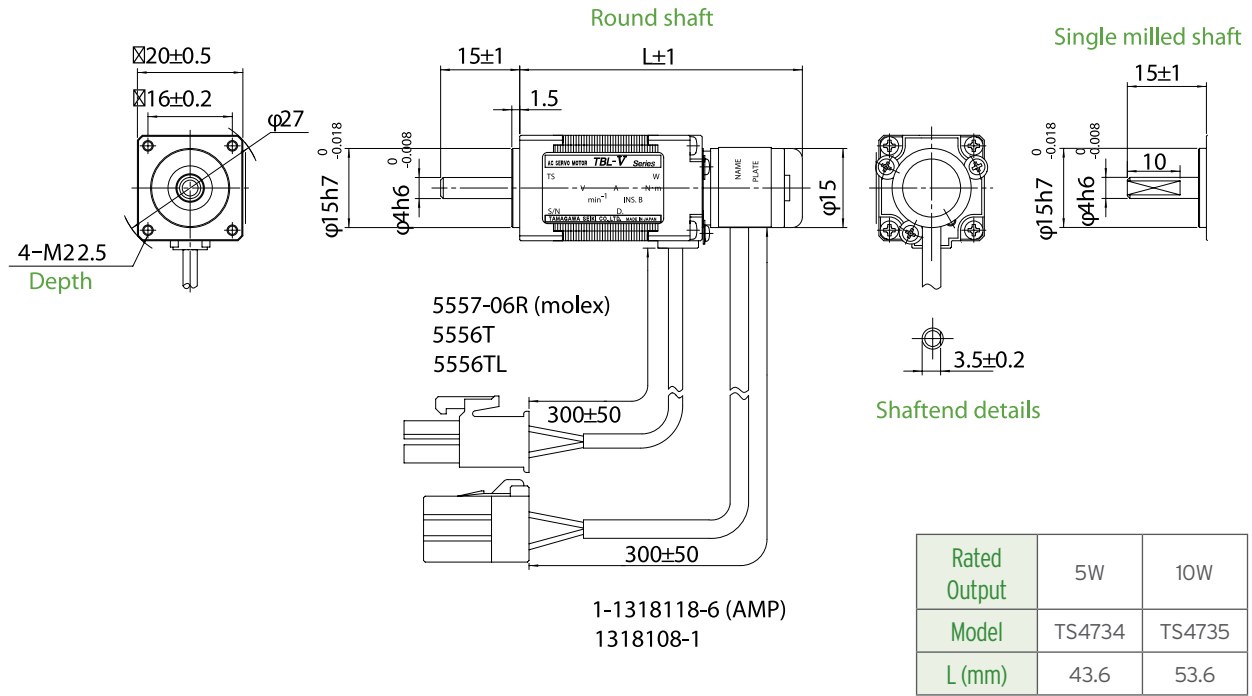

Motor Connection

| PIN No. | Function | Color |
|---------|----------|-------|
| 1 | U | Red |
| 2 | V | Wht |
| 3 | W | Blk |
| 4 | C.G | Grn |
| 5 | - | - |
| 6 | - | - |

Resolver Connection

| PIN No. | Function | Color |
|---------|----------|---------|
| A1 | S2 | Yel |
| A2 | S1 | Red |
| A3 | R1 | Red/Wht |
| A4 | - | - |
| A5 | - | - |
| A6 | - | - |

| PIN No. | Function | Color |
|---------|----------|---------|
| B1 | S4 | Blu |
| B2 | S3 | Blk |
| B3 | R2 | Yel/Wht |
| B4 | - | - |
| B5 | - | - |
| B6 | - | - |

Torque - Speed Characteristics

DC24V • 48V

AC100V • 200V

TS4734 (5W)

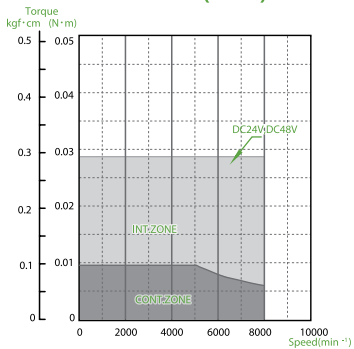

TS4735 (10W)

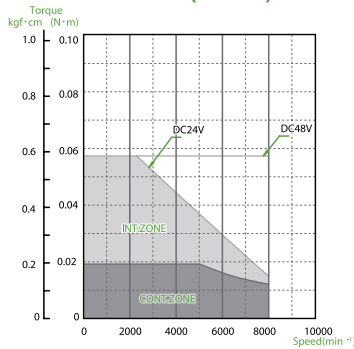

TS4734 (5W)

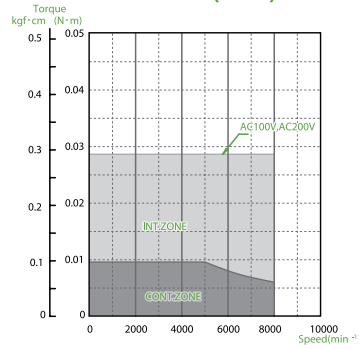

TS4735 (10W)

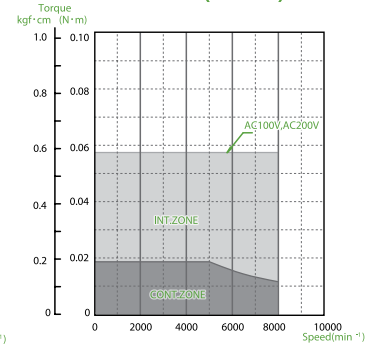

Outline // □28-mm Square (20W, 30W)

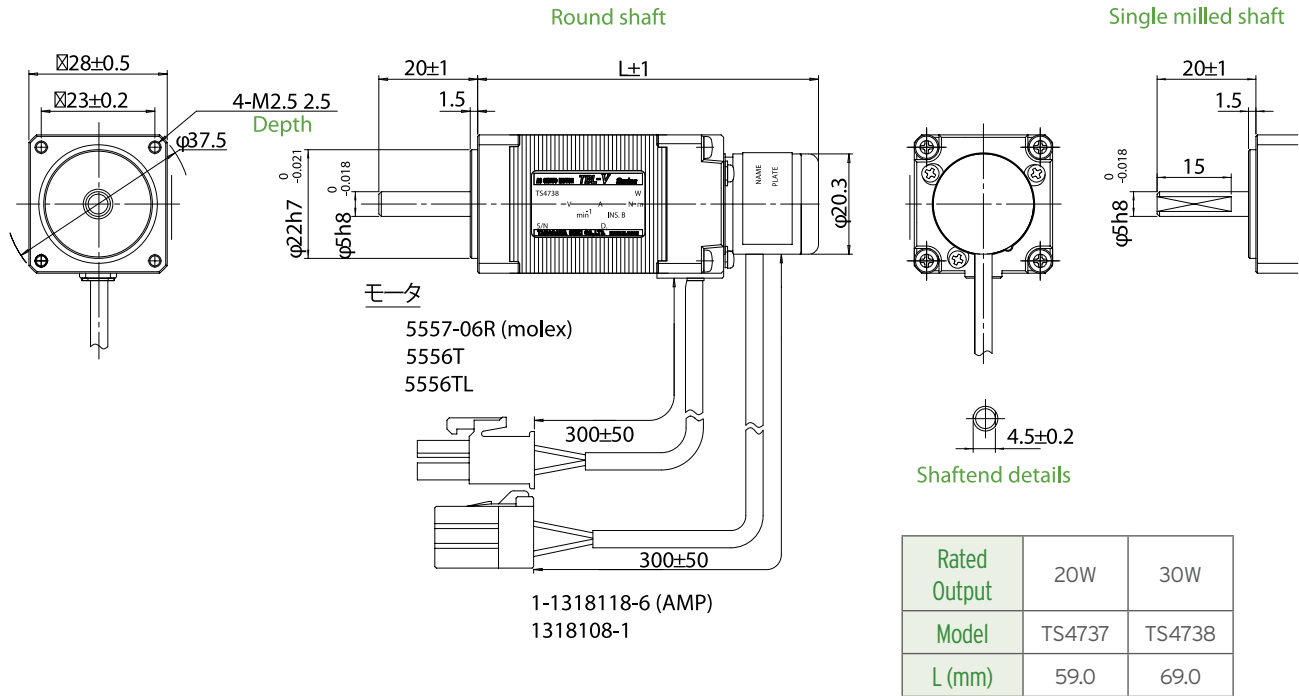

Motor Connection

| PIN No. | Function | Color |
|---------|----------|---------|
| 1 | U | Red |
| 2 | V | Wht |
| 3 | W | Blk |
| 4 | C.G | Grn/Yel |
| 5 | - | - |
| 6 | - | - |

Resolver Connection

| PIN No. | Function | Color |
|---------|----------|---------|
| A1 | S2 | Yel |
| A2 | S1 | Red |
| A3 | R1 | Red/Wht |
| A4 | - | - |
| A5 | - | - |
| A6 | - | - |

| PIN No. | Function | Color |
|---------|----------|---------|
| B1 | S4 | Blu |
| B2 | S3 | Blk |
| B3 | R2 | Yel/Wht |
| B4 | - | - |
| B5 | - | - |
| B6 | - | - |

Torque - Speed Characteristics

DC24V • 48V

AC100V • 200V

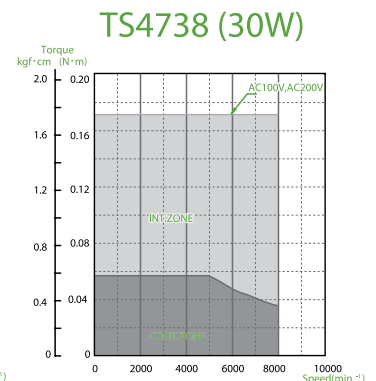
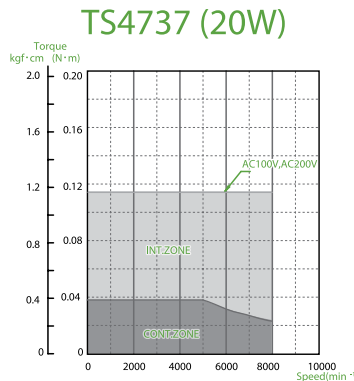
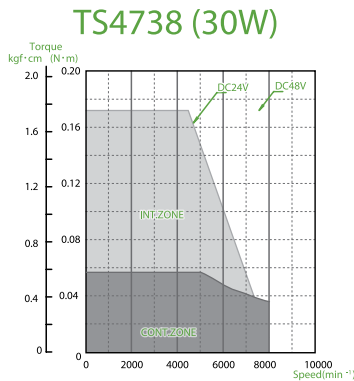
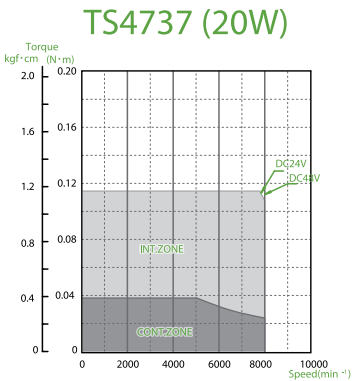

TBL-V Series AC Servo motor

20-28 MM // 5 Watts - 30 Watts, with Miniature HD® Reduction Gearbox

Features // TS47

- Equipped with a Harmonic Drive® reducer. A compact and high-power servo motor combined with a small non-backlash Harmonic reducer.
- High reliability resolver. Equipped with the world's smallest resolver (Smartsyn)

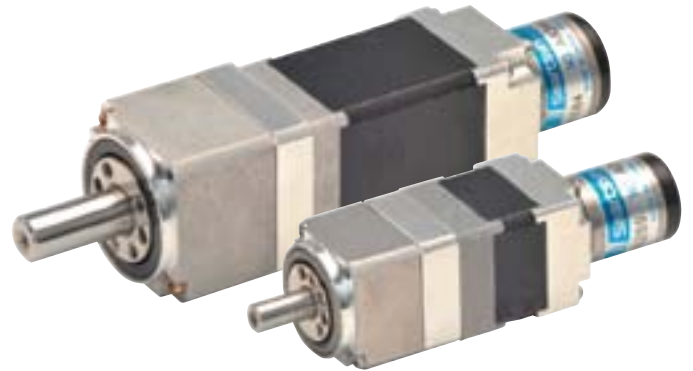

Model // TS47

TS N E

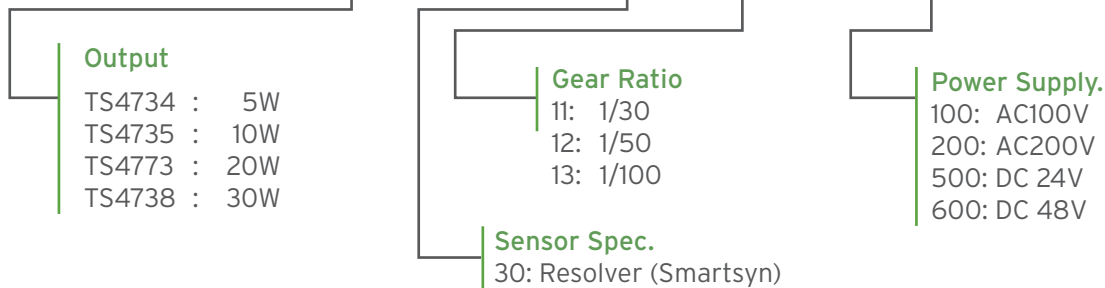

Specifications // TS47

| Motor (Reduction Gear Input) | | | | | | Reduction Gear | | | | | |
|------------------------------|--------|--------|-------------|----------------------------|------------|-----------------|-----------------|-------------|-----------|--------------|-------------|
| Motor Mount Flange | Model | Output | Rated Speed | Rated Current/ Max Current | | Mounting Flange | Reduction Ratio | Rated Speed | Max Speed | Rated Torque | Peak Torque |
| | | | | DC24,48V | AC100,200V | | | | | | |
| (mm) | | (W) | (r/min) | (Arms) | (Arms) | (mm) | | (r/min) | (r/min) | (N·m) | (N·m) |
| 20 | TS4734 | 5 | 5,000 | 1.4/3.2 | 0.7/1.7 | 20.4 | 1/30 | 167 | 267 | 0.089 | 0.61 |
| | | | | 1.4/3.2 | 0.7/1.7 | | 1/50 | 100 | 160 | 0.21 | 1.1 |
| | | | | 1.4/3.2 | 0.7/1.7 | | 1/100 | 50 | 80 | 0.53 | 2.3 |
| | TS4735 | 10 | 5,000 | 1.1/2.1 | 0.6/1.1 | | 1/30 | 167 | 267 | 0.35 | 0.90 |
| | | 9 | | 1.0/2.3 | 0.5/1.2 | | 1/50 | 100 | 160 | 0.53 | 0.81 |
| | | 7 | | 0.9/1.8 | 0.5/0.9 | | 1/100 | 50 | 80 | 0.94 | 2.7 |
| 28 | TS4737 | 20 | 5,000 | 2.7/6.9 | 0.9/2.4 | 30 | 1/30 | 167 | 267 | 0.63 | 2.7 |
| | | | | 2.7/6.9 | 0.9/2.4 | | 1/50 | 100 | 160 | 1.2 | 4.7 |
| | | | | 2.7/6.5 | 0.9/2.4 | | 1/100 | 50 | 80 | 2.6 | 9.0 |
| | TS4738 | 30 | 5,000 | 2.6/5.7 | 0.9/2.0 | | 1/30 | 167 | 267 | 1.2 | 3.3 |
| | | 30 | | 2.6/6.4 | 0.9/2.2 | | 1/50 | 100 | 160 | 2.1 | 6.6 |
| | | 24 | | 2.2/4.5 | 0.7/1.6 | | 1/100 | 50 | 80 | 3.3 | 9.0 |

Outline // 20mm Square (5W, 10W)

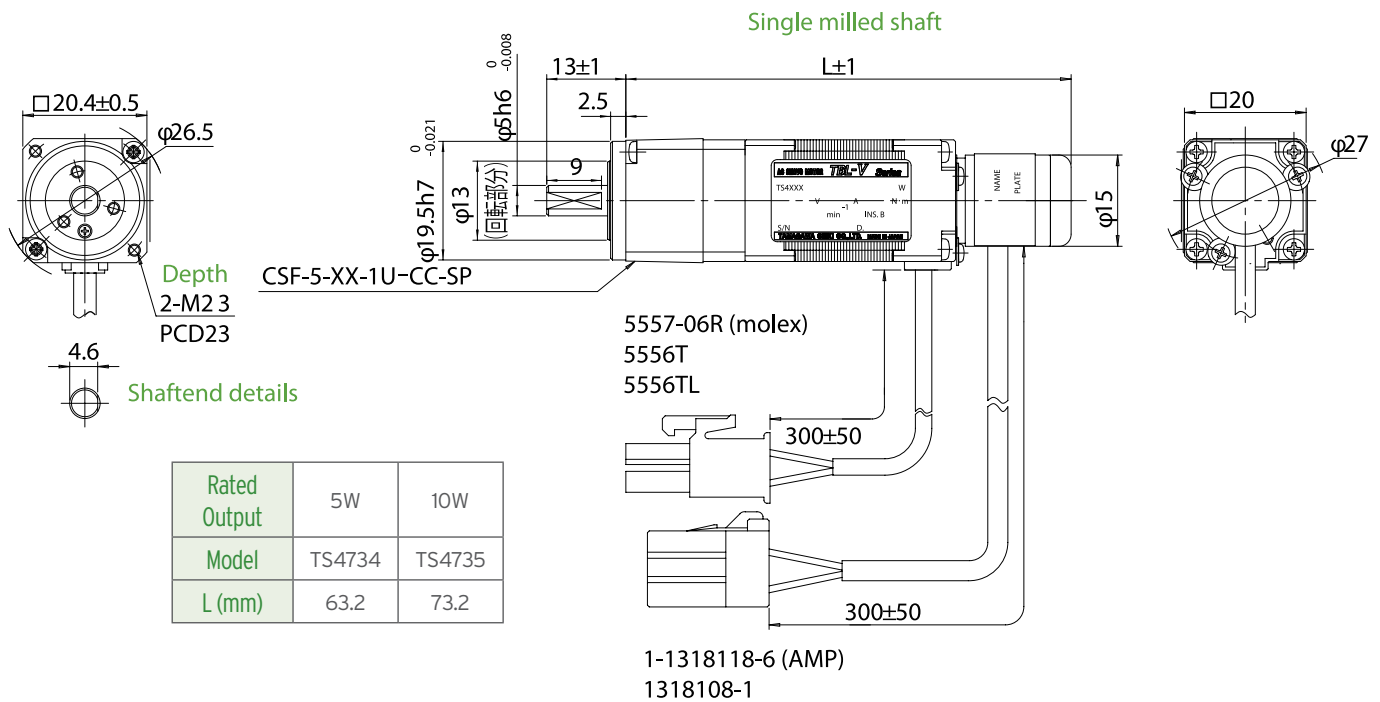

Motor Connection

| PIN No. | Function | Color |
|---------|----------|---------|
| 1 | U | Red |
| 2 | V | Wht |
| 3 | W | Blk |
| 4 | C.G | Grn/Yel |
| 5 | - | - |
| 6 | - | - |

Resolver Connection

| PIN No. | Function | Color |
|---------|----------|---------|
| A1 | S2 | Yel |
| A2 | S1 | Red |
| A3 | R1 | Red/Wht |
| A4 | - | - |
| A5 | - | - |
| A6 | - | - |

| PIN No. | Function | Color |
|---------|----------|---------|
| B1 | S4 | Blu |
| B2 | S3 | Blk |
| B3 | R2 | Yel/Wht |
| B4 | - | - |
| B5 | - | - |
| B6 | - | - |

Outline // 28mm Square (20W, 30W)

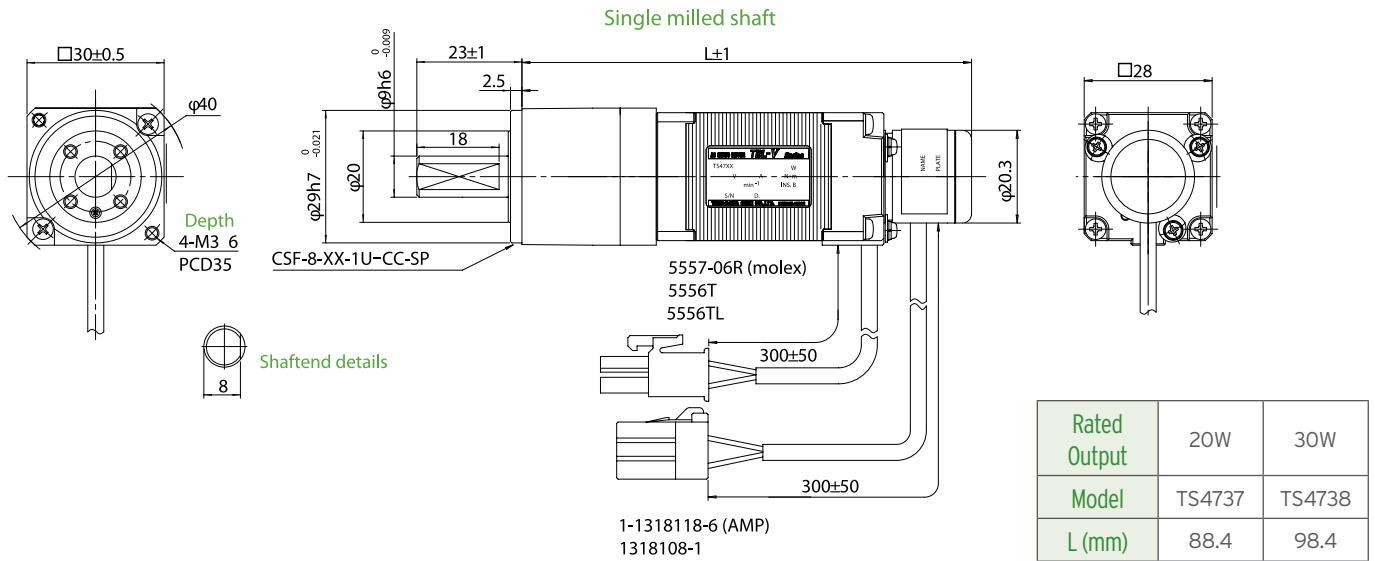

Motor Connection

| PIN No. | Function | Color |
|---------|----------|---------|
| 1 | U | Red |
| 2 | V | Wht |
| 3 | W | Blk |
| 4 | C.G | Grn/Yel |
| 5 | - | - |
| 6 | - | - |

Resolver Connection

| PIN No. | Function | Color |
|---------|----------|---------|
| A1 | S2 | Yel |
| A2 | S1 | Red |
| A3 | R1 | Red/Wht |
| A4 | - | - |
| A5 | - | - |
| A6 | - | - |

| PIN No. | Function | Color |
|---------|----------|---------|
| B1 | S4 | Blu |
| B2 | S3 | Blk |
| B3 | R2 | Yel/Wht |
| B4 | - | - |
| B5 | - | - |
| B6 | - | - |

SV-NET DC24V // TA8410 Servo Driver



Features // TA8410

- SV-NET network. CAN hardware based daisy chain networking minimizes wiring requirements while providing high bandwidth.
- Powerful functions. Stand alone intelligent driver functions include pulse interface and analog speed, torque, and position control, electronic gearing, position and acceleration limits.
- Interfaces with optional SV-NET TA8440 controller providing 8 axis of synchronous control.

Model // TA8410

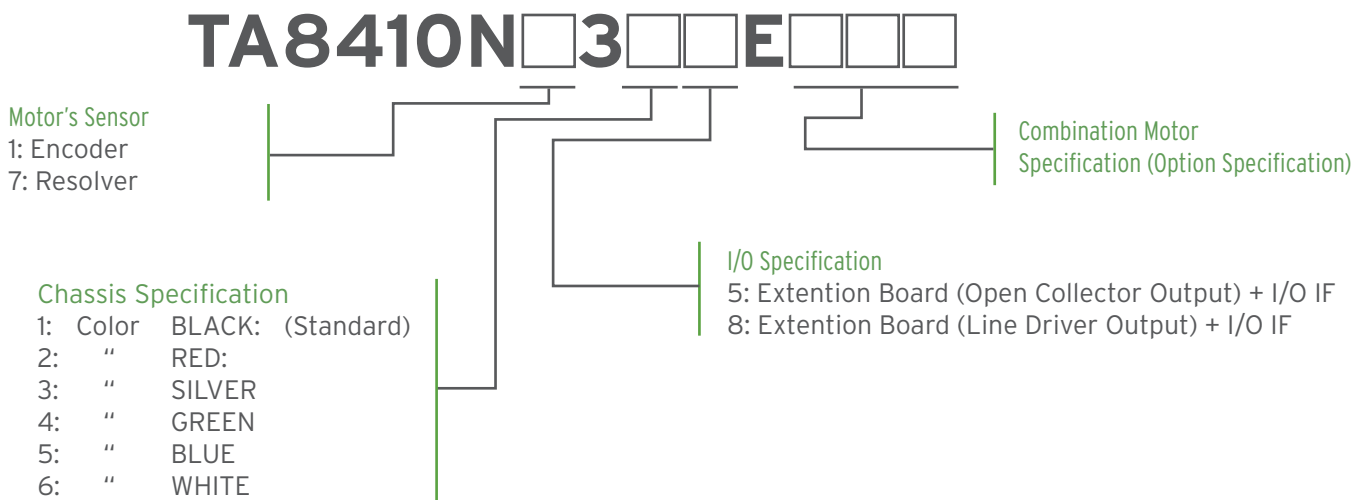

Main Functions // TA8410

| | |
|------------------------------|--|
| Control Commands | Position command input SV-NET or pulse command |
| | Speed command input SV-NET or analog command |
| | Current command input SV-NET or analog command |
| Parameter Settings Functions | Control mode, Position loop gain, Speed loop gain, Speed integration gain, Feed forward, Resonance control filter, Analog command scale setting. Electronic gear setting, Smoothing, Acceleration limit. |
| Protective Functions | Sensor error, Drive power error, Over-heat, Over-speed, Overload. Excessive deviation |
| Applicable Sensors | Brushless resolver (Smartsyn/Singsyn), Optical 17bit- INC/ABS (SVD-DW only), Optical Minimal wiring incremental, (SVD-DW only) |
| Input and Output Signals | Servo ON input, Alarm reset input, Alarm output, In-the-position output, A/B/Z output, (SVD-DW with built-in extension board only) |

Specifications // TA8410

| | | TA8410 Series |
|-----------------------------------|----|--|
| Input Voltage | ※1 | DC24V±10% |
| Drive Power Voltage | ※1 | DC24V~48V±10% |
| Control Power Current | | Communication Protocol:SV-NET Physics Layer: CAN |
| Sensor | | Brushless Resolver (Singsyn) |
| Driver Recognition Resolution | | 2048 (1/rev) |
| Combination Motor | | TBL-i mini Series |
| Combination Motor Output [W] | | 3~15W |
| Operating Temperature Range | | 0~+40°C |
| Storage Temperature Range | | -10~+85°C |
| Operating Humidity | | 90%RH or less (non-condensing) |
| Rotation Direction Definition | ※2 | The CW rotation is assumed to be a positive rotation in view of the motor axial end. |
| Suggested Load Inertia | | Up to thirty times of Motor Inertia |
| Mass | | Approx. 0.3kg |
| Complies with the ROHS directives | | |

※1 Avoid using the same DC24V power supply for the control signals and the drive. When the using a single power supply, inserting a diode into the power circuit is recommended so that the voltage variation on the drive power side does not adversely affect the control side.

※2 Definition of rotating direction can be changed by parameter.

Outline // TA8410

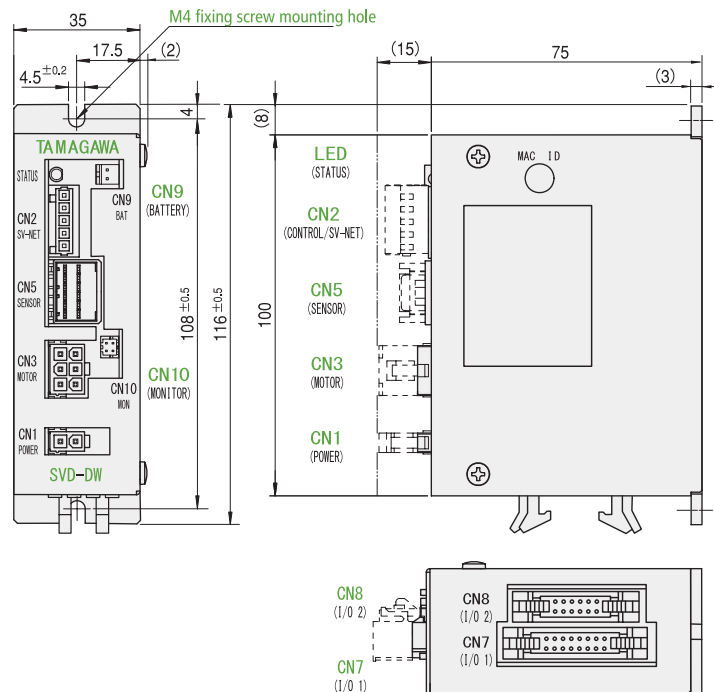

Motor/Driver Combinations // TBL-i mini

| 14.5 mm (Sensor:Resolver) | |
|---------------------------|-----------------|
| Motor Model | Driver Model |
| TS4861 N4050 E500 (3W) | TA8410N73**E101 |
| TS4862 N4050 E500 (5W) | TA8410N73**E102 |
| TS4862 N4050 E500 (10W) | TA8410N73**E103 |
| TS4862 N4050 E500 (15W) | TA8410N73**E104 |

| 19.5 mm (Sensor:Resolver) | |
|---------------------------|-----------------|
| Motor Model | Driver Model |
| TS4871 N4050 E500 (10W) | TA8410N73**E124 |
| TS4872 N4050 E500 (16W) | TA8410N73**E125 |
| TS4873 N4050 E500 (20W) | TA8410N73**E126 |
| TS4875 N4050 E500 (30W) | TA8410N73**E127 |

| 14.5 mm (Sensor:Incremental Encoder2,048C/T) | |
|--|-----------------|
| Motor Model | Driver Model |
| TS4861 N2250 E500 (3W) | TA8410N13**E501 |
| TS4862 N2250 E500 (5W) | TA8410N13**E502 |
| TS4862 N2250 E500 (10W) | TA8410N13**E503 |
| TS4862 N2250 E500 (15W) | TA8410N13**E504 |

| 22 mm (Sensor:Incremental Encoder2,000C/T) | |
|--|-----------------|
| Motor Model | Driver Model |
| TS4631 N2050 E510 (13W) | TA8410N13**E321 |
| TS4632 N2050 E510 (26W) | TA8410N13**E322 |
| TS4633 N2050 E510 (40W) | TA8410N13**E323 |

| 14.5 mm (Sensor:Incremental Encoder4,096C/T) | |
|--|-----------------|
| Motor Model | Driver Model |
| TS4861 N2850 E500 (3W) | TA8410N13**E401 |
| TS4862 N2850 E500 (5W) | TA8410N13**E402 |
| TS4862 N2850 E500 (10W) | TA8410N13**E403 |
| TS4862 N2850 E500 (15W) | TA8410N13**E404 |

| 22 mm (Sensor:Incremental Encoder2,048C/T) | |
|--|-----------------|
| Motor Model | Driver Model |
| TS4631 N2250 E510 (13W) | TA8410N73**E521 |
| TS4632 N2250 E510 (26W) | TA8410N73**E522 |
| ĐTS4633 N2250 E510 (40W) | TA8410N73**E523 |

Cables (optional) // TBL-i mini

| Driver drive power cables | |
|---------------------------|-------------|
| Length | Cable Model |
| 1m | EU9613N10 |
| 3m | EU9613N30 |
| 5m | EU9613N50 |

| Motor Cables | |
|--------------|-------------|
| Length | Cable Model |
| 1m | EU9614N10 |
| 3m | EU9614N30 |
| 5m | EU9614N50 |

| Sensor Cables | |
|---------------|-------------|
| Length | Cable Model |
| 1m | EU9615N10 |
| 3m | EU9615N30 |
| 5m | EU9615N50 |

Motor/Driver Combination // TBL-V

| DC24V/DC48V | |
|-------------------|--------------------|
| Motor model | Driver combination |
| TS4734 (5W-20mm) | TA8410N73**E215 |
| TS4735 (10W-20mm) | TA8410N73**E216 |
| TS4737 (20W-28mm) | TA8410N73**E217 |
| TS4737 (30W-28mm) | TA8410N73**E218 |

| AC100V/AC200V | |
|-------------------|---------------------------------|
| Motor model | Driver combination model |
| TS4734 (5W-20mm) | TA8411N72**E215/TA8411N76**E215 |
| TS4735 (10W-20mm) | TA8411N72**E216/TA8411N76**E216 |
| TS4737 (20W-28mm) | TA8411N72**E217/TA8411N76**E217 |
| TS4737 (30W-28mm) | TA8411N72**E218/TA8411N76**E218 |



Motor/Driver Combination // TBL-V with Gearing

1/30 (N3011)

| DC24V/DC48V | |
|-------------------|--------------------------|
| Motor Model | Driver Combination Model |
| TS4734 (5W-20mm) | TA8410N73**E801 |
| TS4735 (10W-20mm) | TA8410N73**E802 |
| TS4737 (20W-28mm) | TA8410N73**E803 |
| TS4738 (30W-28mm) | TA8410N73**E804 |

1/30 (N3011)

| AC100V/AC200V | |
|-------------------|---------------------------------|
| Motor Model | Driver Combination Model |
| TS4734 (5W-20mm) | TA8411N72**E801/TA8411N76**E801 |
| TS4735 (10W-20mm) | TA8411N72**E802/TA8411N76**E802 |
| TS4737 (20W-28mm) | TA8411N72**E803/TA8411N76**E803 |
| TS4738 (30W-28mm) | TA8411N72**E804/TA8411N76**E804 |

1/50 (N3012)

| DC24V/DC48V | |
|-------------------|--------------------------|
| Motor Model | Driver Combination Model |
| TS4734 (5W-20mm) | TA8410N73**E805 |
| TS4735 (10W-20mm) | TA8410N73**E806 |
| TS4737 (20W-28mm) | TA8410N73**E807 |
| TS4738 (30W-28mm) | TA8410N73**E808 |

1/50 (N3012)

| AC100V/AC200V | |
|-------------------|---------------------------------|
| Motor Model | Driver Combination Model |
| TS4734 (5W-20mm) | TA8411N72**E805/TA8411N76**E805 |
| TS4735 (10W-20mm) | TA8411N72**E806/TA8411N76**E806 |
| TS4737 (20W-28mm) | TA8411N72**E807/TA8411N76**E807 |
| TS4738 (30W-28mm) | TA8411N72**E808/TA8411N76**E808 |

1/100 (N3013)

| DC24V/DC48V | |
|-------------------|--------------------------|
| Motor Model | Driver Combination Model |
| TS4734 (5W-20mm) | TA8410N73**E809 |
| TS4735 (10W-20mm) | TA8410N73**E810 |
| TS4737 (20W-28mm) | TA8410N73**E811 |
| TS4738 (30W-28mm) | TA8410N73**E812 |

1/100 (N3013)

| AC100V/AC200V | |
|-------------------|---------------------------------|
| Motor Model | Driver Combination Model |
| TS4734 (5W-20mm) | TA8411N72**E809/TA8411N76**E809 |
| TS4735 (10W-20mm) | TA8411N72**E810/TA8411N76**E810 |
| TS4737 (20W-28mm) | TA8411N72**E811/TA8411N76**E811 |
| TS4738 (30W-28mm) | TA8411N72**E812/TA8411N76**E812 |

* Specifications for TA8411 Driver available upon request.



Myostat Motion Control Inc.

www.myostat.ca

+1 905-836-4441 • info@myostat.ca

Warranty

Tamagawa Seiki warrants their products to be free from defects in material or workmanship under normal use and service for a period of one year from the date of shipment from its factory. This warranty excludes any damage caused by careless use of the product by the user. Following the expiration of the warranty, Tamagawa Seiki offers repair service, with charge, to maintain the quality of the product. The user is advised that multiple safety measures should be incorporated into their product or system in order to prevent any damage caused by failure of our product.



ALL specifications are subject to
change without notice

T12-1661N2 2,000 - 2011/10

'11.10